

OP-55: WING TIP NAV STROBE LIGHTING

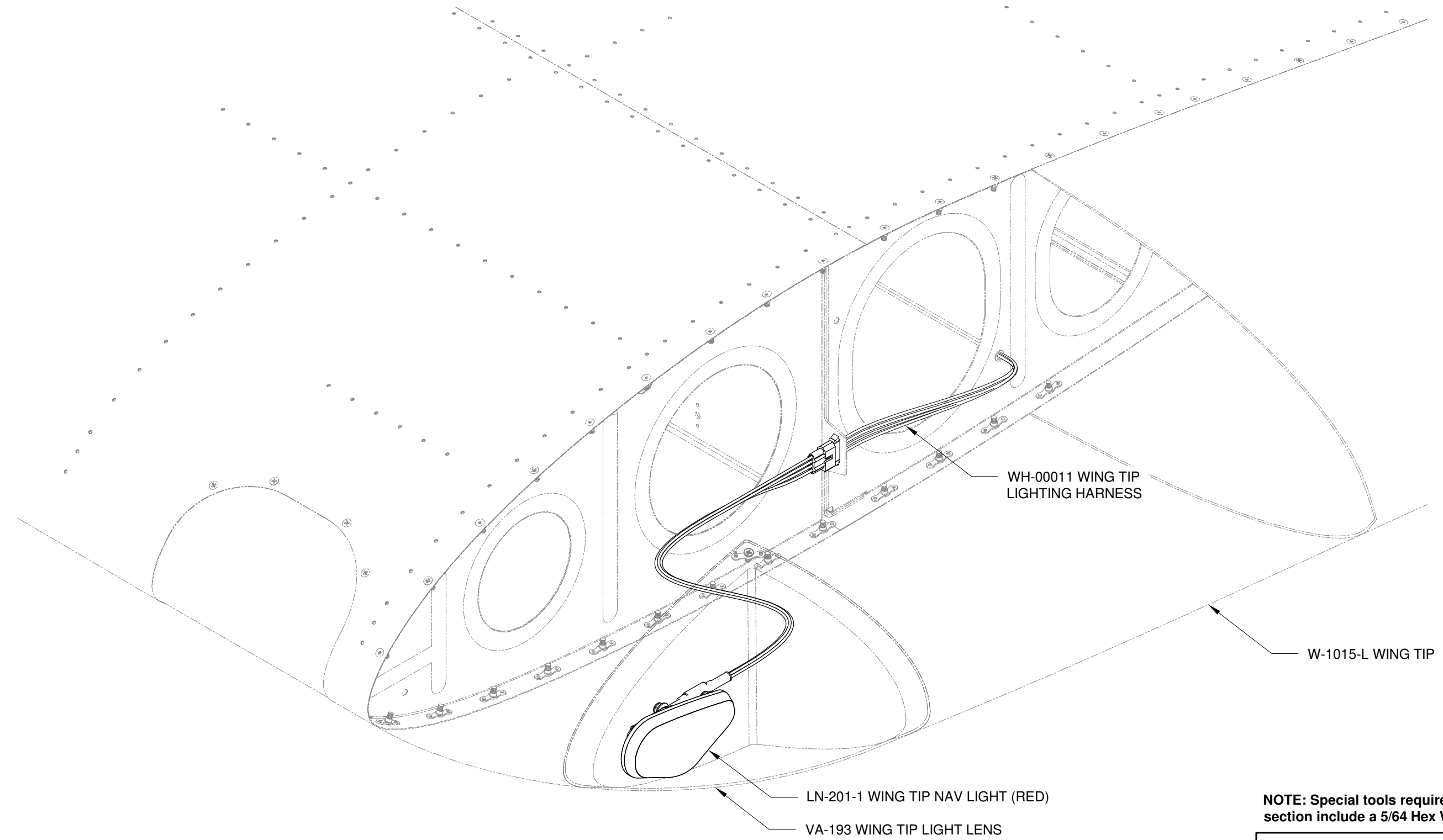

NOTE: Special tools required to complete this section include a 5/64 Hex Wrench

DATE OF COMPLETION: _____
 PARTICIPANTS: _____
 DATE: 08/27/19 | REVISION: 2 | RV-ALL (EXCEPT RV-12) | PAGE OP55-01



NOTE: See Section 5.18 for more tips on working with the fiberglass fairings. Fiberglass will quickly dull tools. Locate and use the tools set aside for use in attaching the empennage fairings when working with the fiberglass wing tips.

Except where separate instructions and/or figures exist for both left and right sides of the aircraft, only the left side parts, assemblies, or installations will be shown.

It is the builder's choice as to whether to complete all steps for the left side before repeating those steps for the right side or to complete each step for both left and right sides before moving to the next step.

RV-14 Installation shown. Refer to the AeroLEDs installation instructions for more information.

Where required, aircraft specific templates are included on pages OP55-05 thru OP55-07. Due to variations in the wing tip, the template shape may not exactly match the shape of the wing tip. Use the best approximate location and ensure the wing tip nav light is parallel to the wing chord line.

Step 1: Remove the W-1015-L Wing Tip From the Wing.

Remove the VA-193 Wing Tip Light Lens from the wing tip.

Cut out the Left Wing Tip Drilling Template on Page OP55-05. Tape the template to the wing tip as shown in Figure 1.

Use a center-punch to mark the holes on the wing tip.

Step 2: Drill #27 the three screw holes in the W-1015-L Wing Tip

Drill #27 the wire chase holes in the wing tip.

Use a step drill to enlarge to 1/2 [12.7 mm] the wire chase holes in the wing tip. Trim the excess material to form a slot as shown in Figure 1.

Remove the Left Wing Tip Drilling Template from the wing.

Step 3: Cover the lens of the LN-201-1 Wing Tip Nav Light with masking tape to protect it.

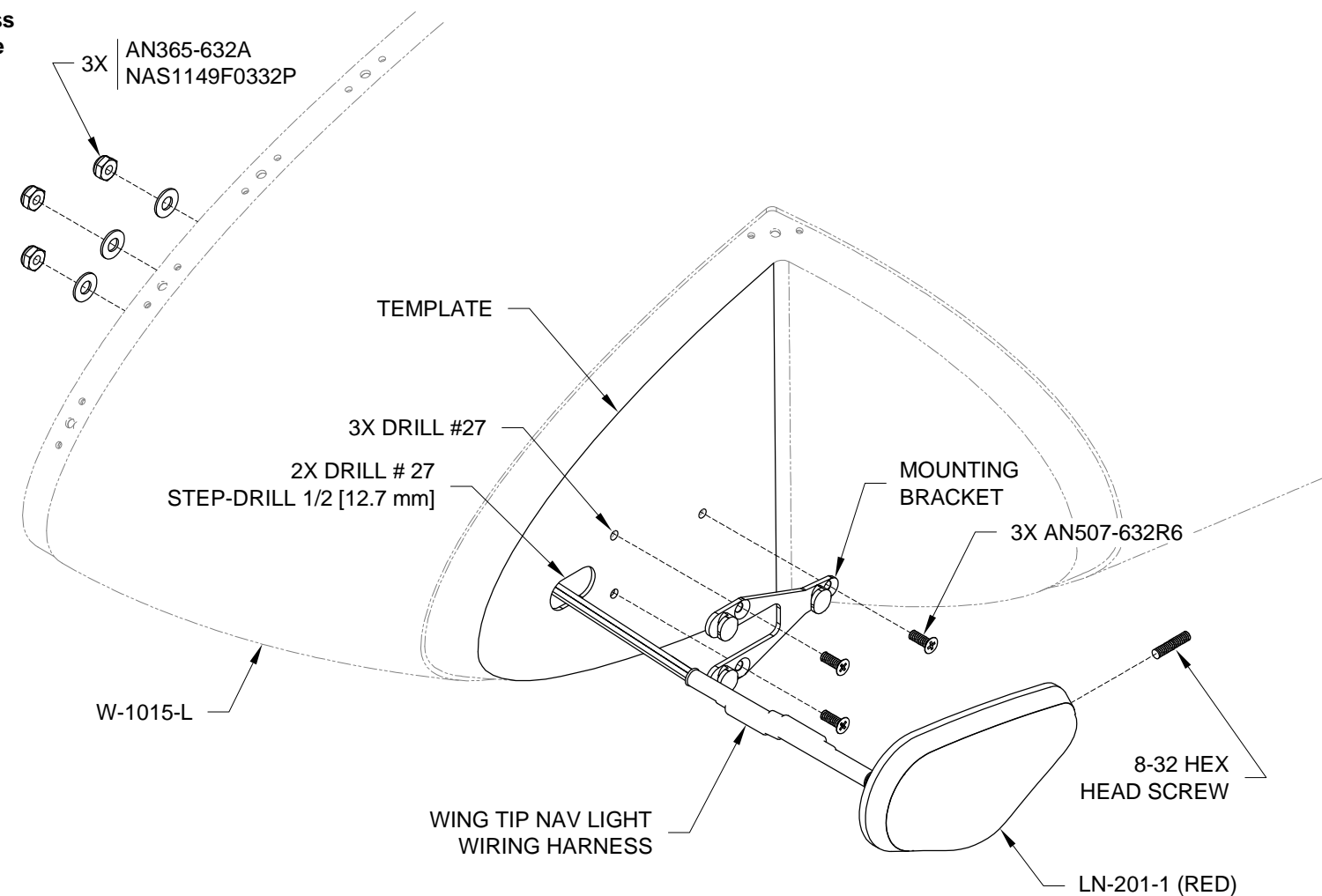
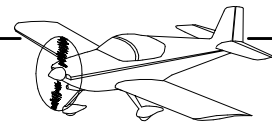

FIGURE 1: WING TIP NAV LIGHT INSTALLATION



NOTE: See Section 5.21 for more information on wire stripping and closed barrel terminals.

Step 1: Strip the BLK, YEL, GRN & RED wires in the LN-201-1 Wing Tip Nav Light (RED) and crimp on the Molex Pins provided with the light as shown in Figure 1.

Step 2: Label the Molex Plug "C401P". See Figure 1.

Step 3: Insert the BLK, YEL, GRN & RED wires in the Wing Tip Nav Light Wiring Harness into C401P as shown in Figure 1.

NOTE: The Wing Tip Nav Lights and Landing Light are grounded to the fuselage via the L418 (YEL) wire in the WH-00011 Wing Tip Wiring Harness and the WH-00125 RV-14 Common Fuselage Wiring Harness (installed later). This grounding location was chosen to minimize electromagnetic interference with wing mounted ADAHRS and Magnetometers. See Figure 4.

Step 4: (If landing lights will be installed) Order two "LL LED KIT A" from Van's Aircraft and connect the L422 (BLK) wire from C401J as described in Section OP-52A.

Step 5: (if Landing Lights will NOT be installed) Strip the L422 (BLK) wire coming from C401J, and the L418 (YEL) wire from the WH-00011 Wing Tip Lighting Harness. Connect these two wires together using the butt splice called out in Figure 3.

Step 6: Install the LN-201-1 Wing Tip Nav Light as shown on Page OP55-02, Figure 1.

Step 7: Connect C401P and C401J as shown in Figure 2.

Step 8: Reinstall the W-1015-L Wing Tip and VA-193 Wing Tip Light Lens.

WARNING: Do not test the wing tip nav lights without temporarily grounding the appropriate ground wires!

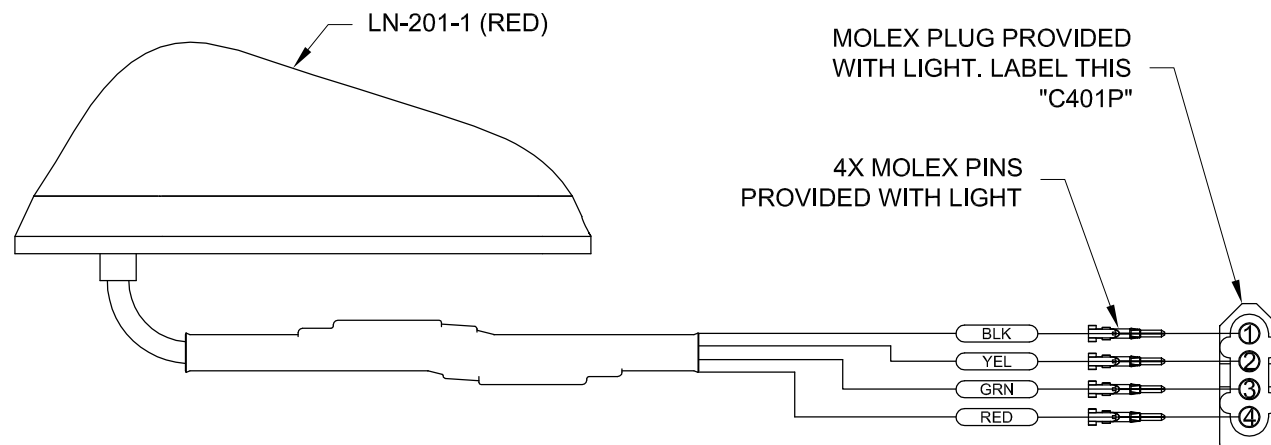

FIGURE 1: WING TIP NAV LIGHT WIRES

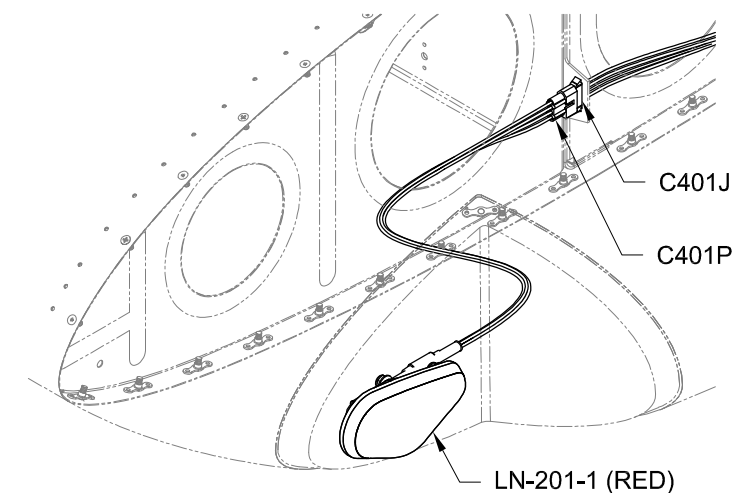

FIGURE 2: CONNECT C401P & C401J

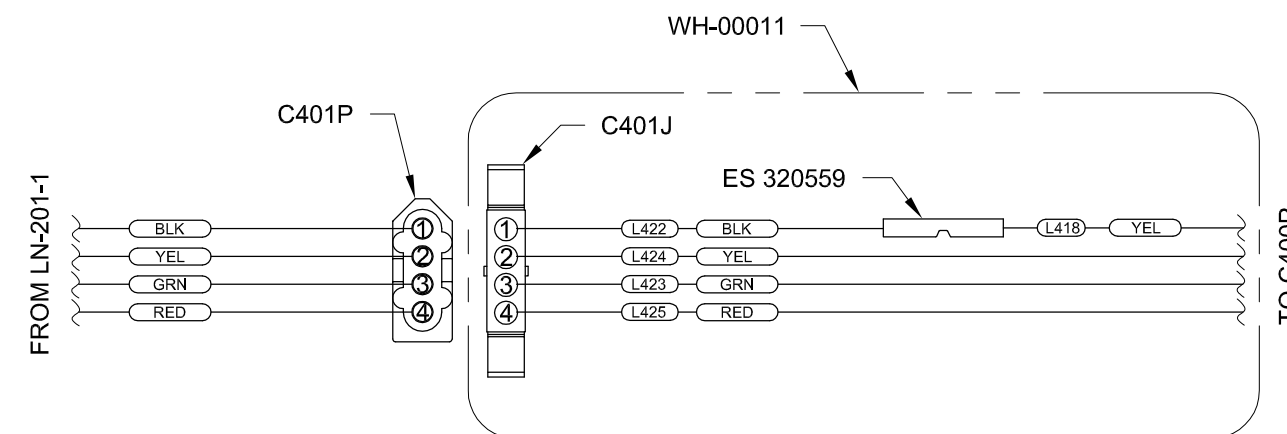

FIGURE 3: WING TIP LIGHTING HARNESS MODIFICATION (IF LANDING LIGHTS WILL NOT BE INSTALLED)

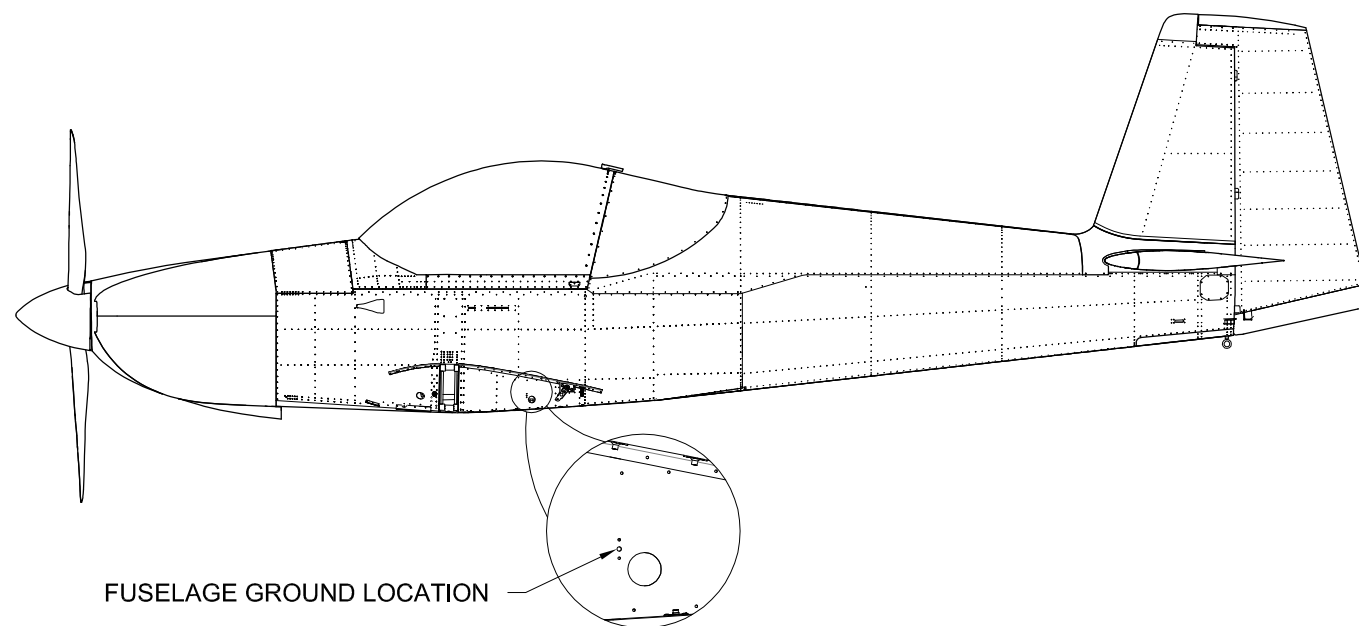

FIGURE 4: GROUND LOCATION

NOTE: The following instructions apply **ONLY** to builders installing a Dynon Skyview EFIS.

NOTE: Instructions on this page assume the builder has completed installation of the WH-00125 RV-14 Common Fuselage Harness.

NOTE: The ES-00184 Noise Filter is located in the left wing root as shown in Figure 3. The ground location depicted shows a prototype RV-14. See Page OP55-03, Figure 4 for the final production version ground location.

Step 1: Remove the Molex socket common to the L2191 (WHT) and L2192 (WHT) wires from C400J, then cut off the socket and discard it.

Step 2: Strip the ends of the L2191 (WHT) and L2192 (WHT) wires, then crimp the wires together using the male spade connector called out in Figure 1.

Step 3: Fabricate the L940 wire from an 8 in. (20.32 cm) length of 18 gauge wire and the components called out in Figure 1.

Step 4: Insert the Molex socket from the L940 wire into C400J as shown in Figure 1.

Step 5: Connect the spade connectors to the ES-00184 Noise Filter as shown in Figure 2.

Step 6: Use tie-wraps to secure the ES-00184 Noise Filter approximately as shown in Figure 3.

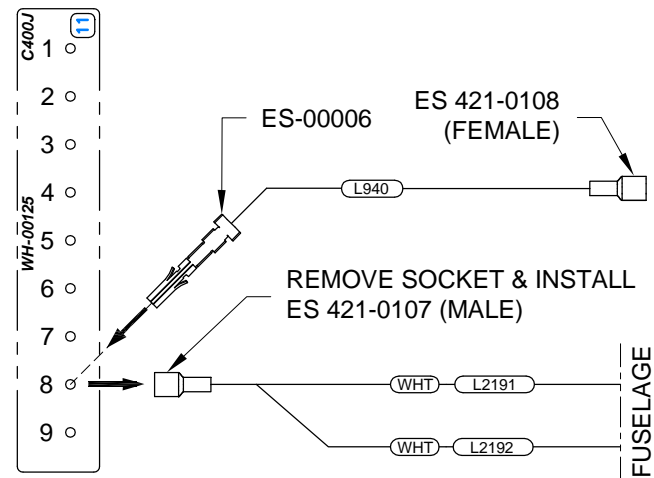

FIGURE 1: RV-14 COMMON FUSELAGE HARNESS MODIFICATION
LEFT WING ROOT, ONLY PERTINENT WIRES SHOWN.
AFS/DYNON ONLY

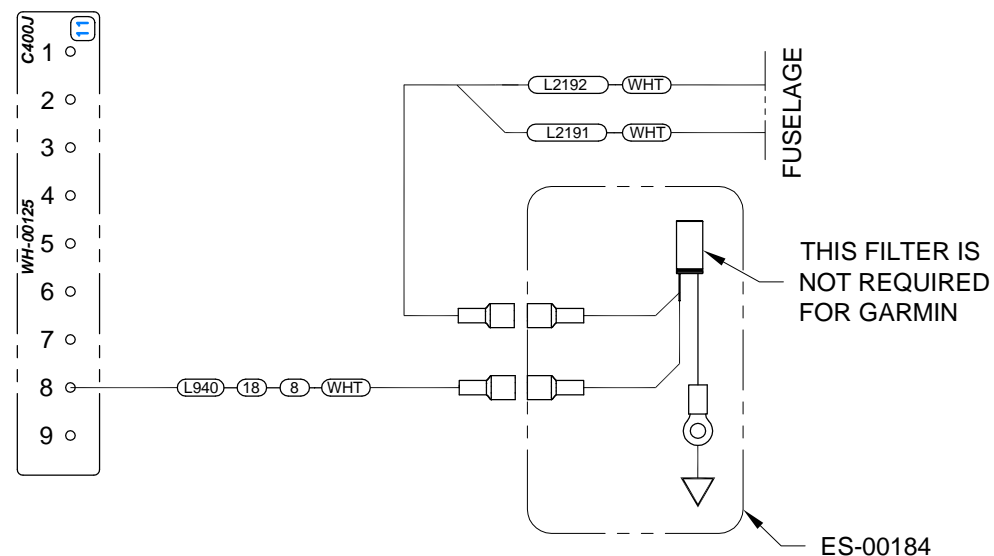

FIGURE 2: NOISE FILTER INSTALLATION
AFS/DYNON ONLY

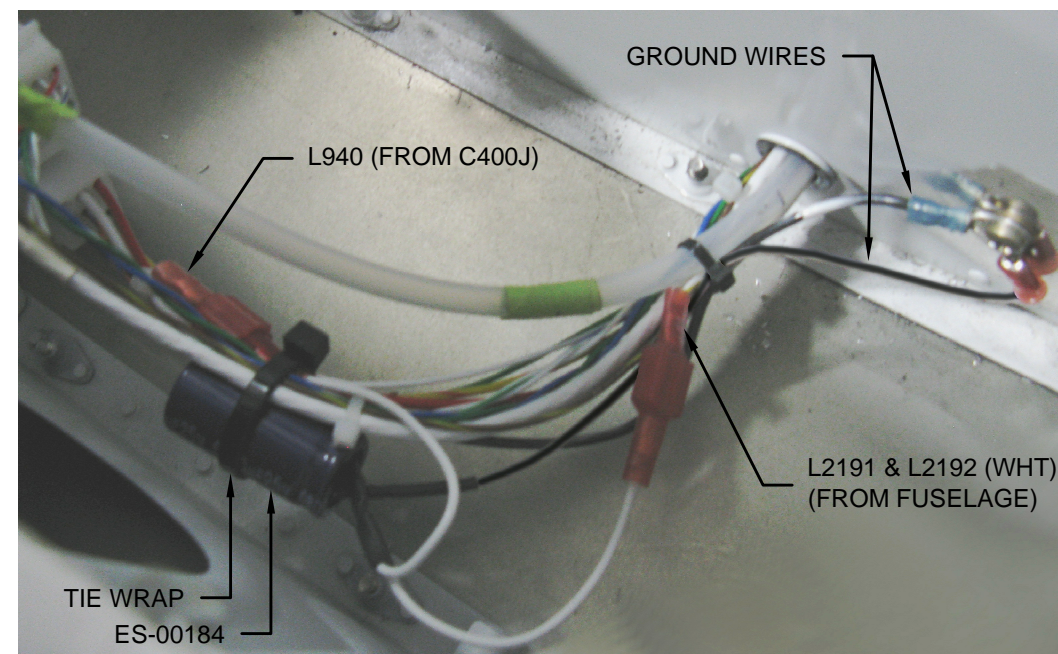

FIGURE 3: SECURING THE NOISE FILTER
AFS/DYNON ONLY

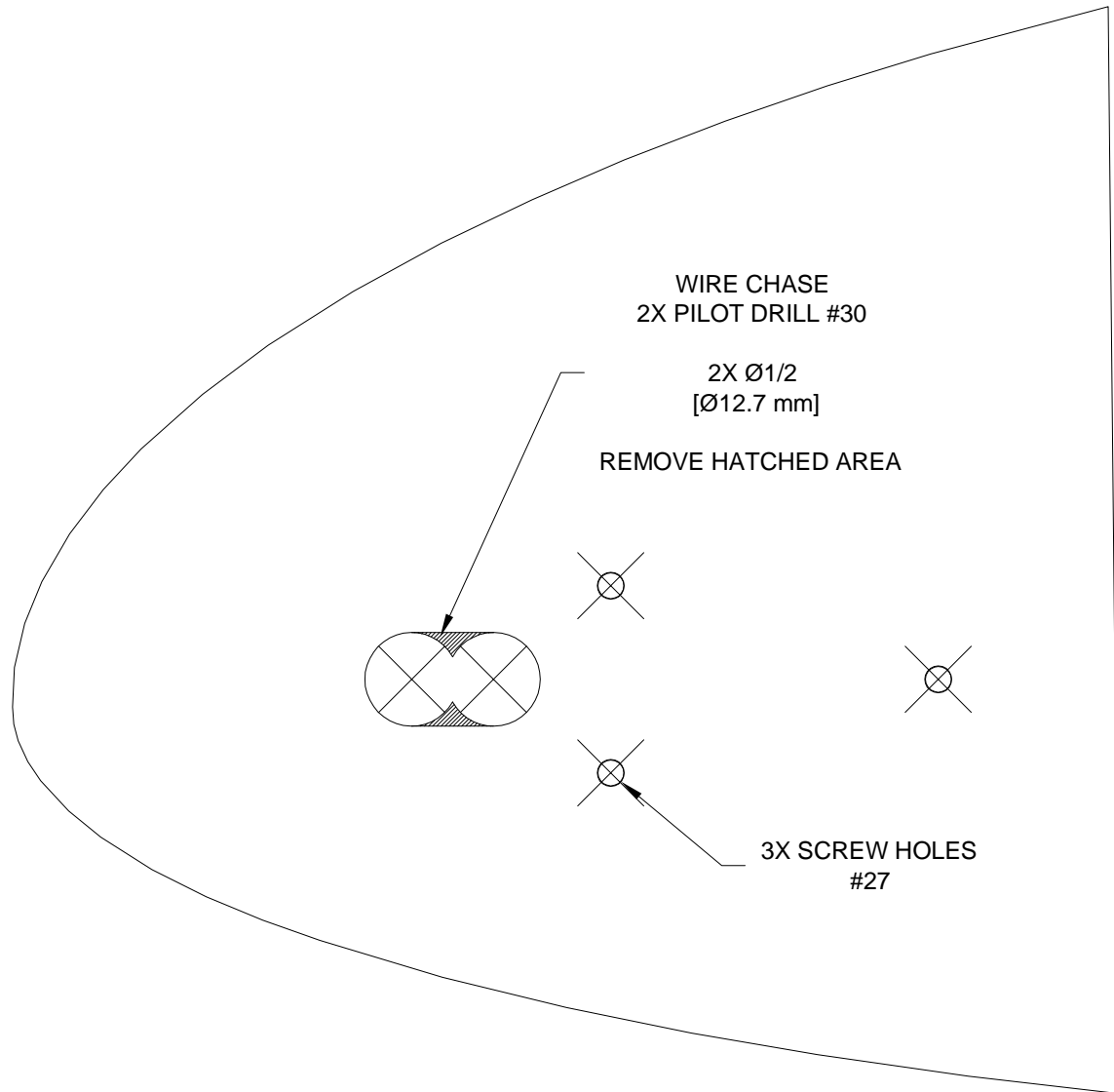
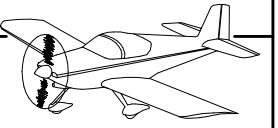

FIGURE 1: RV-7/8 LEFT WING TIP DRILLING TEMPLATE

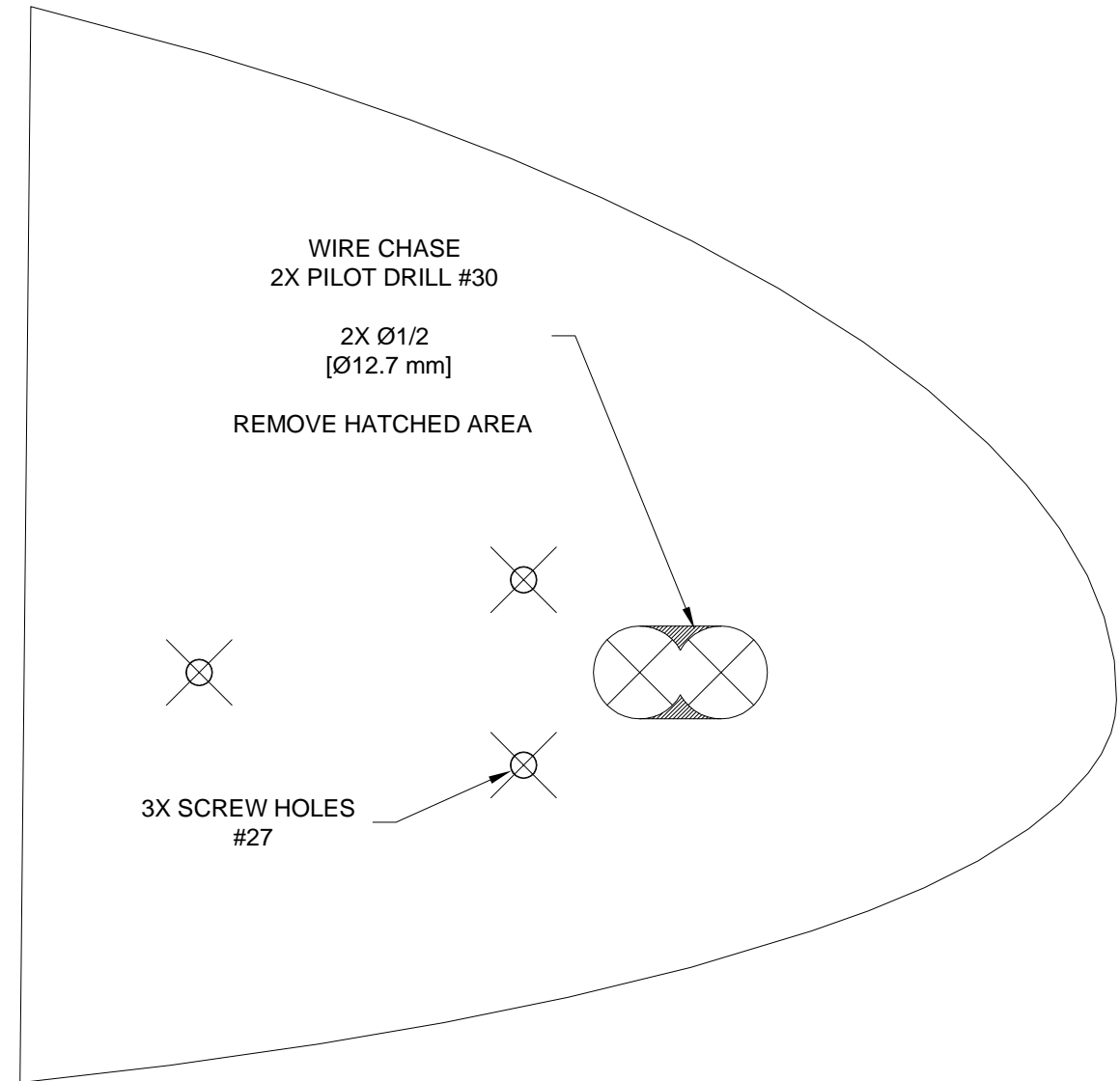

FIGURE 2: RV-7/8 RIGHT WING TIP DRILLING TEMPLATE

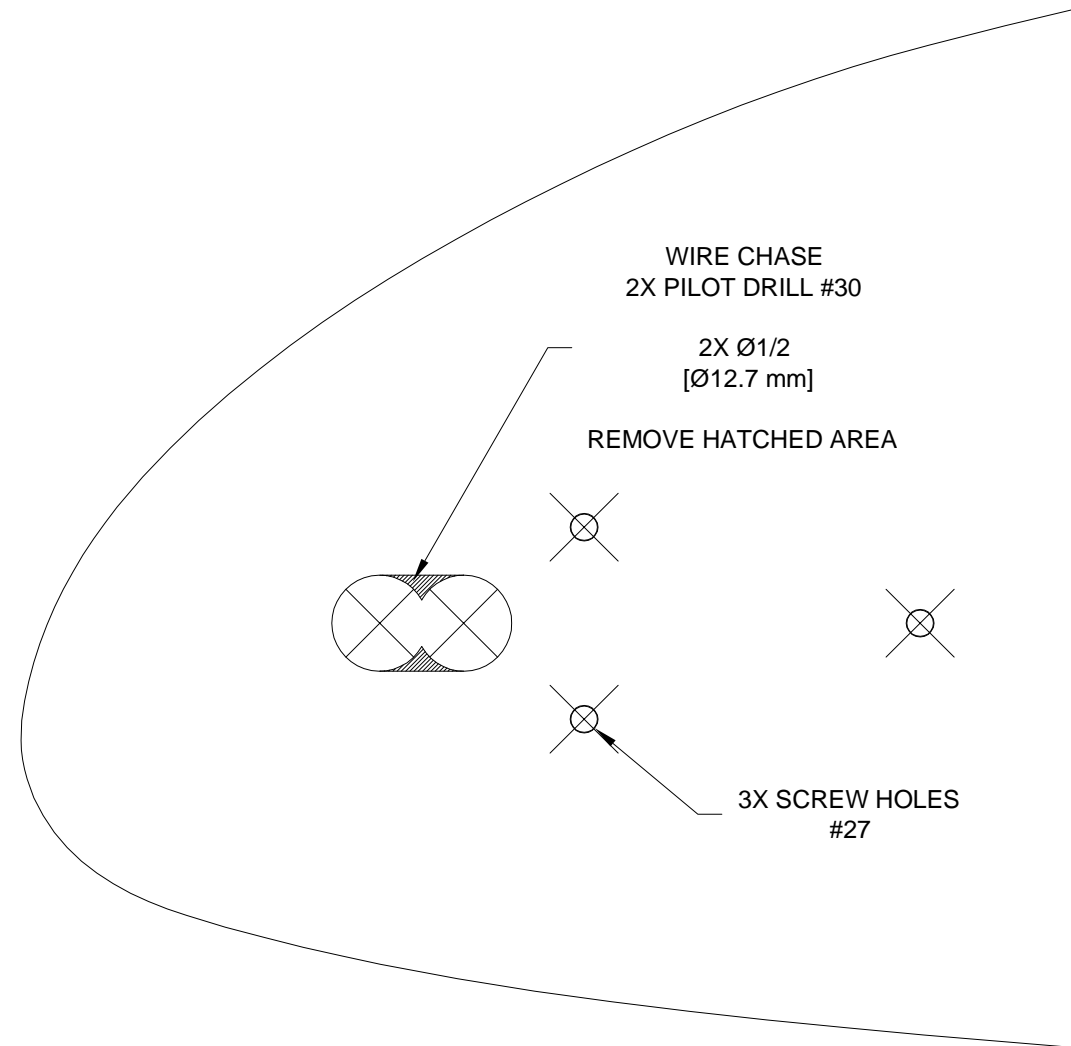

FIGURE 1: RV-9 LEFT WING TIP DRILLING TEMPLATE

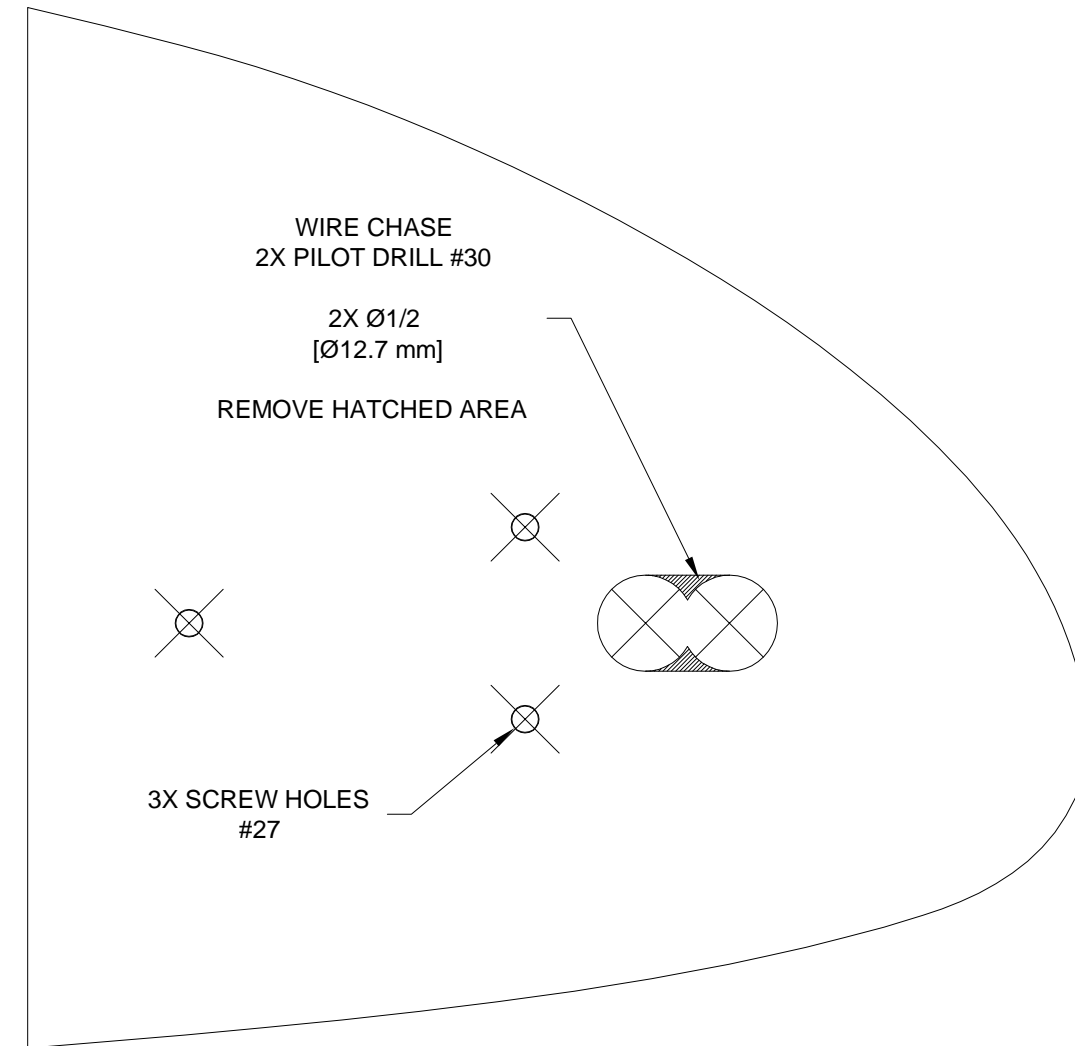

FIGURE 2: RV-9 RIGHT WING TIP DRILLING TEMPLATE

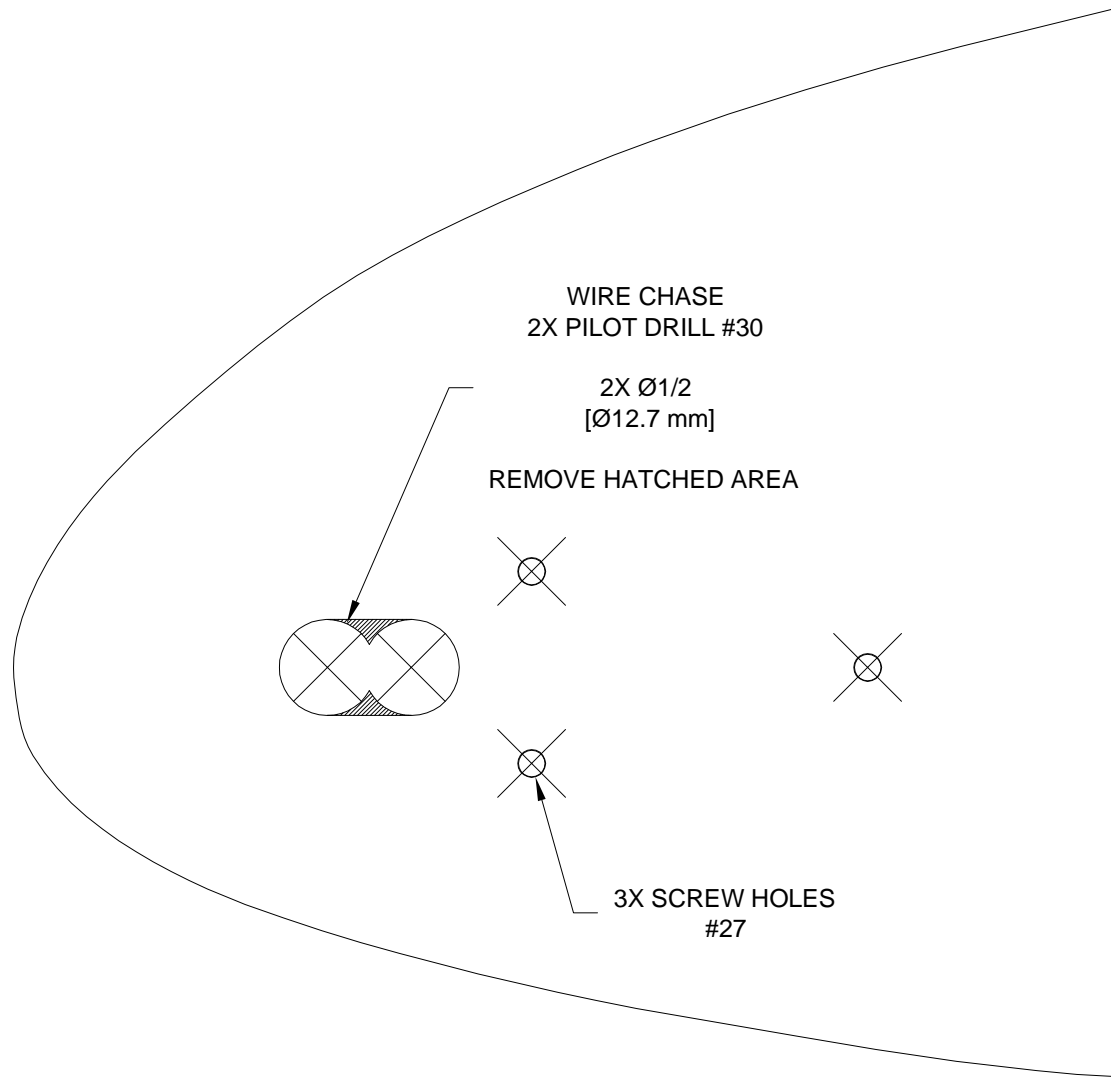
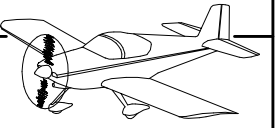

FIGURE 1: RV-10/14 LEFT WING TIP DRILLING TEMPLATE

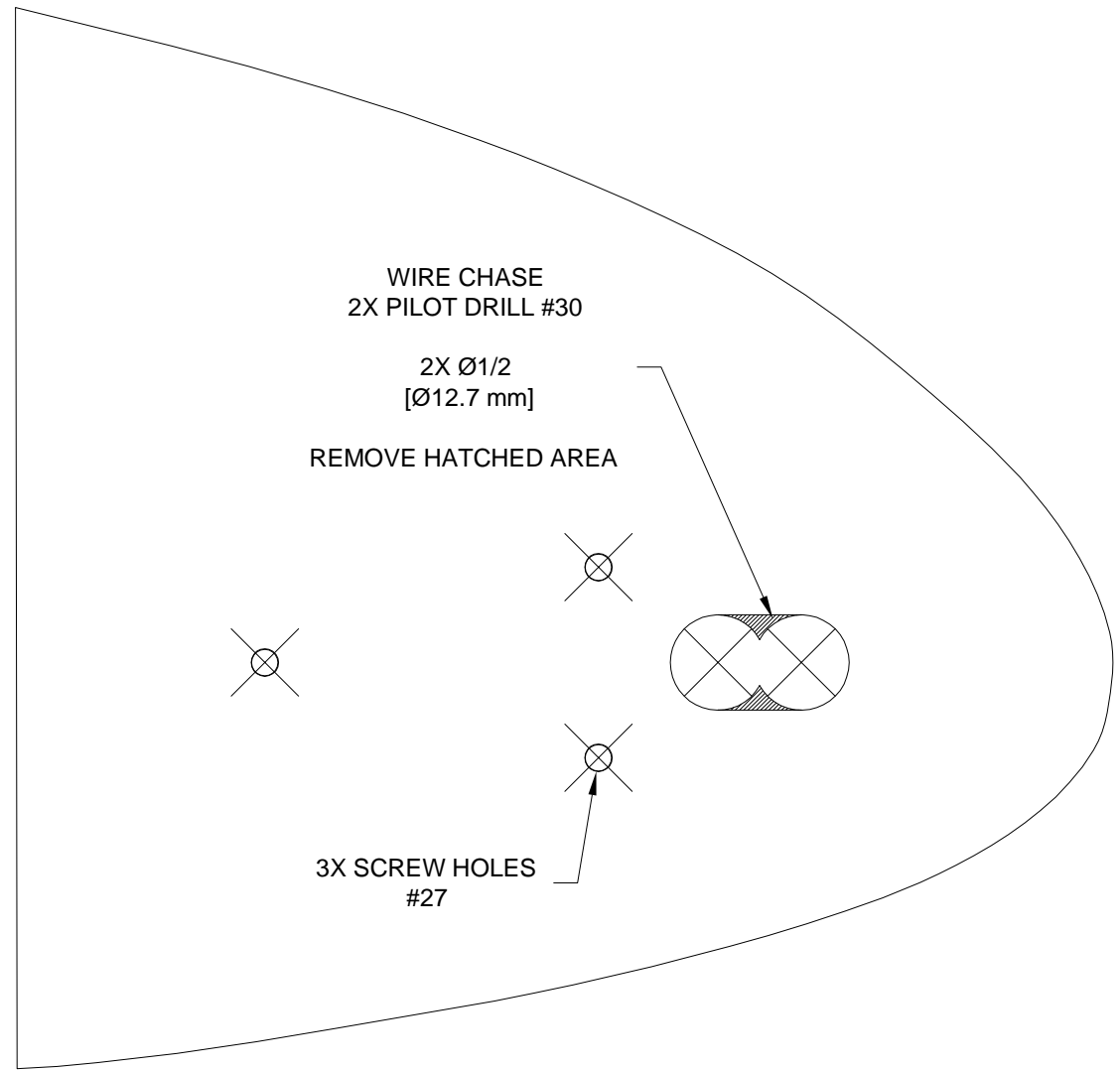

FIGURE 2: RV-10/14 RIGHT WING TIP DRILLING TEMPLATE



THIS PAGE INTENTIONALLY LEFT BLANK